

Parts List				
Item	Qty.	Code	Description	Max. Torque
1	1 Pc.	573770AC	Grille Guard FS	-
1 Pc. BRK-57377 Bracket kit includes				
2	2 Pc.	269202AA	Auxiliary bracket	-
3	2 Pc.	269103AA	Spacer bracket	-
4	1 Set.	574794BA	Lower bracket	-
1 Pc. KTE-57377 Hardware kit includes				
5	6 Pc.	-	1/2" Hex nut	70 Lb/Ft
6	2 Pc.	-	1/2 x 1 1/2" Hex head bolt	70 Lb/Ft
7	12 Pc.	-	1/2" Flat washer	-
8	6 Pc.	-	1/2" Lock washer	-
9	4 Pc.	-	1/2 x 2" Hex head bolt	70 Lb/Ft

Required Tools (Not included)	
Qty.	Description
1	Ratchet
1	Extension
1	Socket / wrench 3/4"
1	Socket / wrench 10 - 18mm
1	Socket / wrench 21mm
1	Screw driver flat

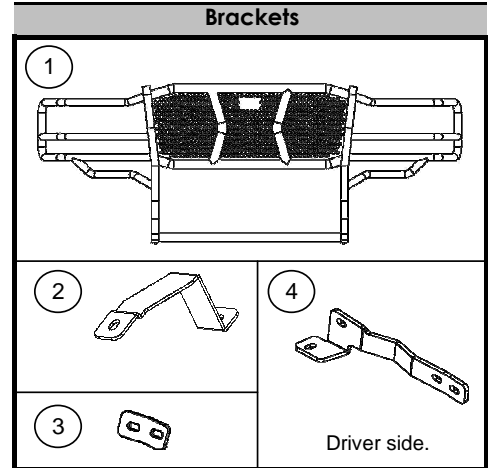

Instructions

1. Before beginning the installation, please read all directions carefully and verify that all necessary hardware is accounted for. If any parts are missing, stop the installation and contact your distributor immediately.
2. Beginning with the driver side remove the nuts, bolts and splash shield from the wheel well and lower bumper valance. **See picture 1.**
3. Remove the nut, bolts and tow hook from the frame. **See picture 2.**

NOTE: The splash shield and tow hook will be rein stalled.

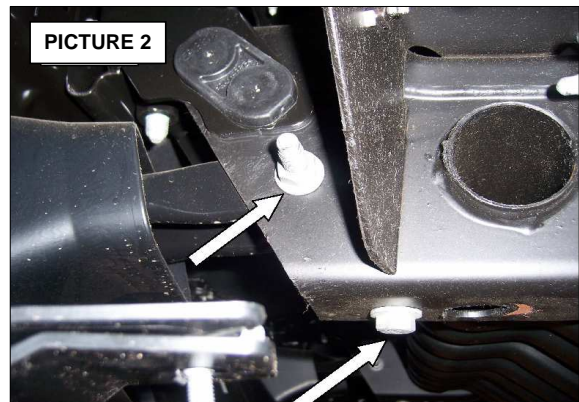
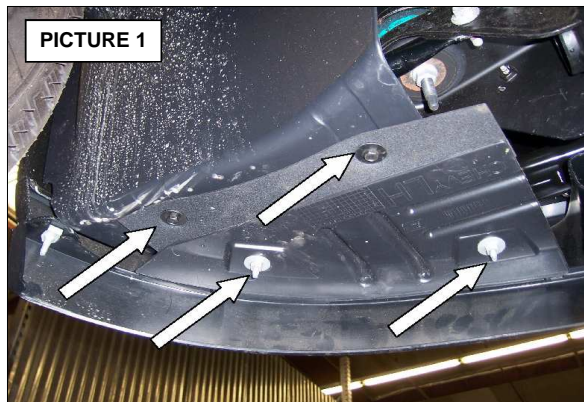

4. From behind the bumper balance, position the driver side lower brackets so the leg of the bracket extends out through the tow hook opening, then rotate and align the bracket with the side and bottom of the frame. **See pictures 3 and 4.**

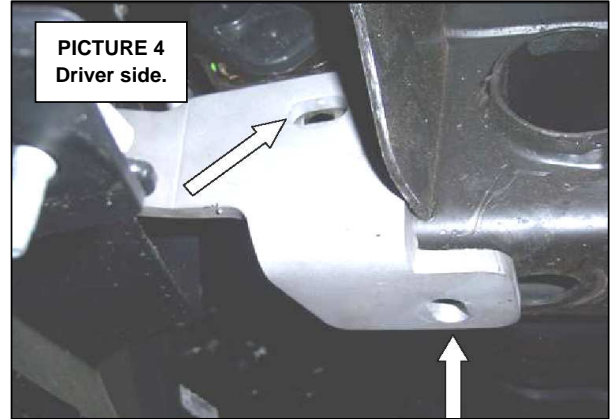
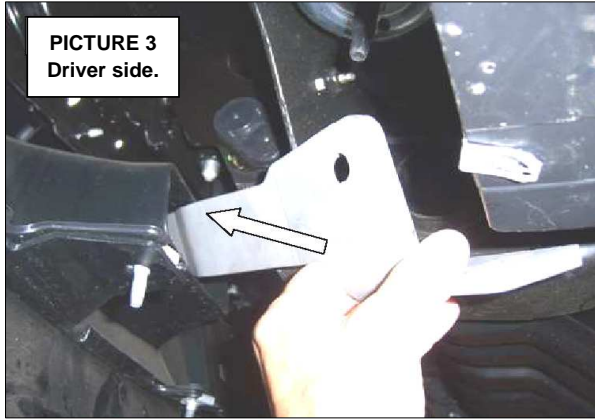

5. Position the tow hook inside the frame, align the bracket and tow hook with the holes in the frame and rein stall the tow hook bolts and nut. Leave the tow hook bolts and nuts loose for final adjustment. **See pictures 5 and 6.**

Repeat the above steps to install the passenger side lower bracket.

NOTE: If your vehicle is not equipped with factory tow hooks, attach the lower brackets to the frame using the 1/2 x 1 1/4" hex bolts, flat washers, lock washers and hex nut supplied.

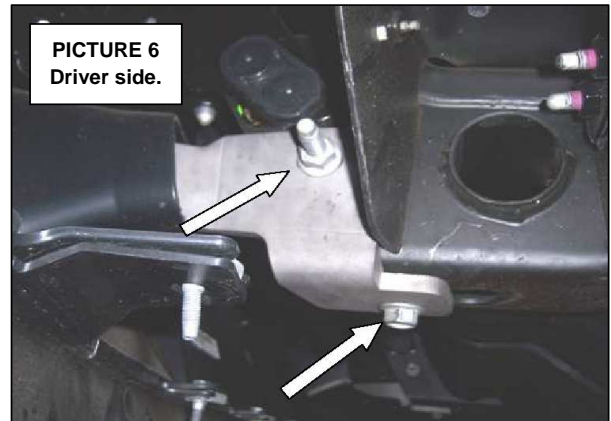
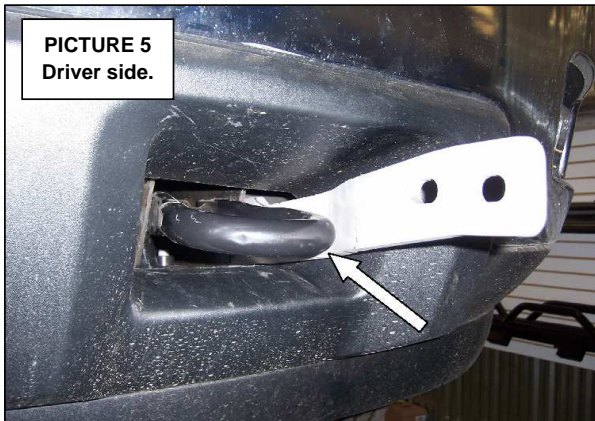

6. Open the hood, locate and remove the plastic rivets (5) per side securing the radiator cover and the screws (2) per side securing the top of the grille. **Picture 7 & 8.**

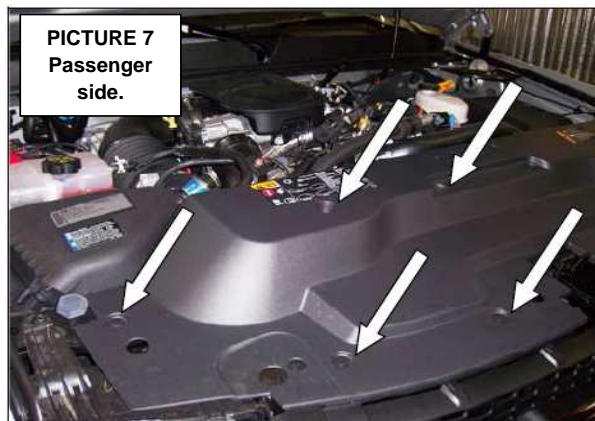

7. Remove the bumper bracket bolt from the top of the driver side frame rail. Align the driver side upper bracket with the hole in the frame and rein stall the bumper bolt. Leave the bolt loose for final adjustment. **See pictures 9 and 10.**

Repeat the above steps to install the passenger side upper bracket.



8. Attach the Grille Guard FS to each lower bracket using: ½" x 2" hex bolts, ½" flat washers, ½" lock washers and ½" hex nuts, and to each upper bracket using: ½" x 1 ½" hex bolt, ½" flat washer, ½" lock washer and ½" hex nut. **See Picture 11 & 12.**

Note: Position the supplied 3/8" spacers between the lower brackets and the grille guard side plates.

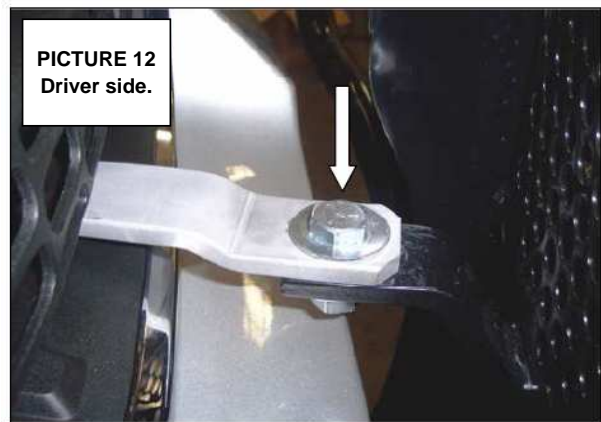

9. Align the Grille Guard FS with the front of the vehicle and tighten all nuts and bolts.

Remember to check and retighten the hardware periodically.

10. Reinstall all parts before removed of the vehicle.

11. Fill out your warranty card and place it inside your vehicle.

